

# 448. Mutual Positioning of the Being Assembled Cylindrical Parts Under Controlled Dry Friction

**B. Bakšys<sup>1</sup>, T. Sokolova<sup>2</sup>**

Kaunas University of Technology,

Kestucio str. 27, LT – 44312. Kaunas, Lithuania

**e-mail:** <sup>1</sup>*broniuss.baksys@ktu.lt*, <sup>2</sup>*tatjana.sokolova@ktu.lt*

*(Received 21 January 2009; accepted 10 March 2009)*

**Abstract.** Applied for automated assembly the displacement of the part under controlled dry friction is analyzed. The paper deals with vibrational non - impact displacement of a mobile - based body when the body is subjected to kinematical excitement. Based on a simplified dynamic model of vibratory displacement under controlled dry friction the areas of the system and excitation parameters sets exist with different motion regimes and when controlling dry friction at particular time intervals. There were formed dependencies of vibratory displacement from dynamic system and excitation parameters. Based on performed part-to-part positioning analysis were designed schemas of vibratory assembly devices under controlled of the dry friction those may be used for joining of the cylindrical parts.

**Keywords:** automated assembly, displacement, dry friction

## Introduction

Recently scientific and technical innovation, related to mechanical aids and manufacturing automation (orientation of the parts in respect of the predetermined basic surfaces, feeding of the oriented blank parts to the assembly position, parts location, interdependent orientation and matching), deserves more attention. In order to ensure the successful implementation it is necessary to develop efficient and reliable technological mechanisms and assembly devices [1].

Assembly is the final stage of the production, when the parts are arranged in respect of the each other according to the predetermined order. Performing the arrangement of machines, devices or other product manufacturing process, it is very important to use an efficient assembly technology and equipment to gain production quality and productivity. Development of any complex product involves sequential joining of the parts, assembly units and other components into overall product. Assembly operations in mechanical engineering carry 20 to 50 % of the total production time in mentioned industry [1, 2].

The process of automated assembly involves two main stages: mutual positioning of the connective surfaces and joining of the parts [3]. During the automated assembly different size parts must take such a position, which makes possible to join them. Positioning of the being assembled parts is one of the most important tasks of the automated assembly process. During positioning, the parts are located in respect of each other conforming predefined accuracy so, that it is possible to perform automated assembly [4 – 7].

A method of vibratory positioning of the being assembled parts under controlled dry friction, which makes automated assembly more reliable, is analyzed in this article. Applying this method, vibratory excited movably based part displaces and turns in respect of the immovably based part and so connective surfaces get matched. Based on the mentioned method, it is possible to design new schemas of mechanisms and assembly devices, which assure feeding of the parts into assembly position, mutual positioning and joining [8].

Vibratory displacement controlling dry friction coefficient by high frequency elastic vibrations was examined. This is the most simple control method, when by means of piezoelectric vibrators stationary or running waves of elastic strains are excited in the bodies. Applying this technique it is easy to control the moments of vibration occurrence or stopping and so control the values of friction coefficient at predetermined intervals [8].

### Dynamical model and equations of motion

To investigate vibratory displacement controlling dry friction a simplified dynamic model of vibratory assembly device, which was made not taking into account turn of the movably based part during the displacement, is enough to obtain results (Fig. 1).

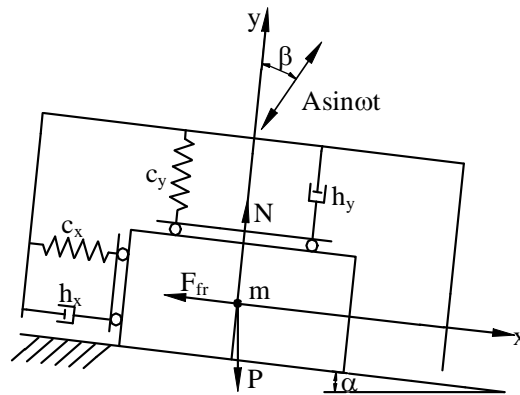


Fig. 1. Dynamical model of vibratory assembly device

Movably based part represented by a  $m$  mass body which displacement is restricted due to elastic and damping forces, characterized respectively by the stiffness  $c_x$  and damping  $h_x$ , coefficients. Elastic fixing elements of the gripper are characterized by  $c_y$  and  $h_y$  coefficients and are preventing vertical displacement of the body. Changing the position of static equilibrium of the platform, it is possible to control the initial pressing force of the parts. Besides, the body is influenced by gravitation  $P$ , kinematical excitation force  $F \sin \omega t$  (where  $F = c_y \cdot A$ ) and dry friction force  $F_{fr}$ .

The equation describing the motion of movably based part  $m$  can be written in dimensionless form (Eq. 1):

$$\ddot{\xi} + h_1 \dot{\xi} + \gamma^2 \xi = \sin \tau \sin \beta - f(\tau) \times \\ \times (\mu \cos \alpha + v - \sin \tau \cos \beta) + \mu \sin \alpha, \text{ when } \dot{\xi} > 0$$

$$\ddot{\xi} + h_1 \dot{\xi} + \gamma^2 \xi = \sin \tau \sin \beta + f(\tau) \times \quad (1)$$

$$\times (\mu \cos \alpha + \nu - \sin \tau \cos \beta) + \mu \sin \alpha, \text{ when } \dot{\xi} < 0.$$

where dimensionless parameters are introduced:

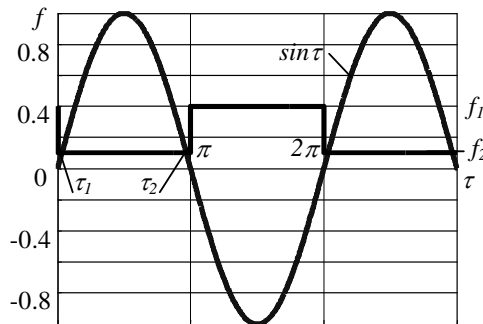
$$\tau = \omega t; \xi = \frac{m\omega^2}{c_y A} x; \nu = \frac{y_{st}}{A}; \mu = \frac{mg}{c_y A};$$

$$h_1 = \frac{h_x}{m\omega}; k^2 = \frac{c_x}{m}; \gamma = \frac{k}{\omega}.$$

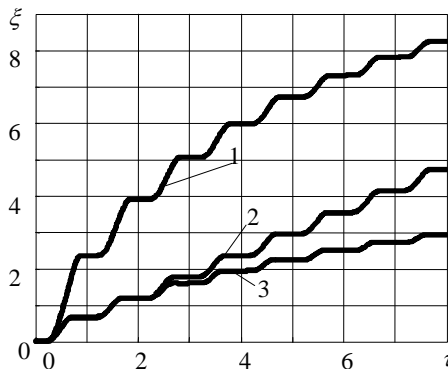
In Eq. 1 the expression  $f(\tau)(\mu \cos \alpha + \nu - \sin \tau \cos \beta)$  determinable the friction force  $F_{fr}$  between the body and the platform.

Vibratory displacement is examined controlling dry friction force at particular time intervals, turning-on/off high frequency vibrator, which excites elastic vibrations. Actuating and stopping moments are determined with respect to the excitation period of the body [8].

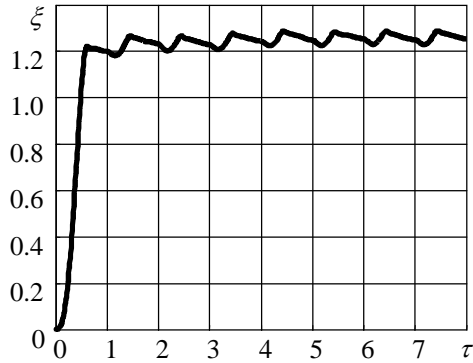
If elastic vibrations of the platform are induced, dry friction coefficient decreases and smaller friction force prevents the displacement of the body. Turning off the vibrations results a stepwise increase in friction coefficient. Time moments when high frequency vibrations are excited or stopped are denoted as  $\tau_1$  and  $\tau_2$  (Fig. 2).



**Fig. 2.** Stepwise change in dry friction coefficient  $f(\tau)$  versus to the period  $2\pi$  of the excitation force

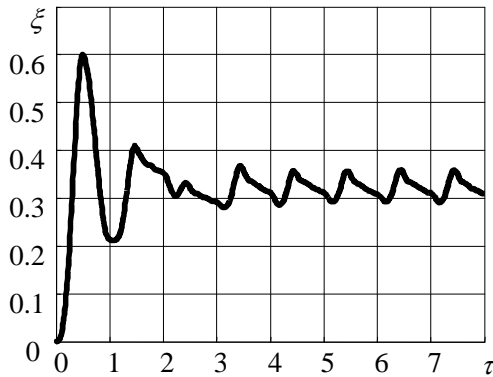


**Fig. 3.** Jerking displacement of the body as: 1 -  $h_1=0.01, \gamma=0.2; \mu=3.0; \nu=0.3$ ; 2 -  $h_1=0.01, \gamma=0.01; \mu=0.4; \nu=1.0$ ; 3 -  $h_1=0.01, \gamma=0.2; \mu=1.0; \nu=1.0; f=(0.1; 0.3)$

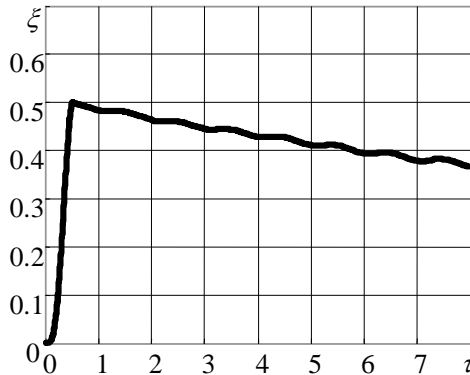


**Fig. 4.** Stick - slip displacement of the body and vibration near the position of dynamic equilibrium when  $\tau_1=0$  and  $\tau_2=\pi$ .  $h_1=0.01$ ;  $\alpha=0.1$ ;  $\beta=0.3$ ;  $\gamma=0.5$ ;  $\mu=1.0$ ;  $\nu=0.05$ ;  $f=(0.1; 0.3)$

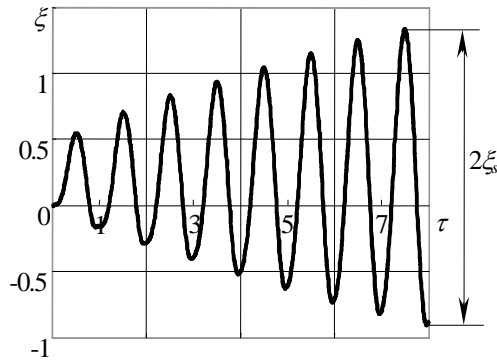
The body on an inclined plane moves from the position of static to dynamic equilibrium. The law of motion depends both on system and excitation parameters and may be of different character (Fig. 3 – 7). Those graphs are obtained as  $\tau_1 = 0$ ,  $\tau_2 = \pi$ .



**Fig. 5.** Nearly periodical motion near the position of dynamic equilibrium:  $h_1=0.01$ ;  $\alpha=0.1$ ;  $\beta=0.3$ ;  $\gamma=1.0$ ;  $\mu=1.0$ ;  $\nu=0.05$ ;  $f=(0.1; 0.3)$



**Fig. 6.** Decrease of body displacement:  $h_1=0.01$ ;  $\alpha=0.1$ ;  $\beta=0.3$ ;  $\gamma=0.85$ ;  $\mu=1.0$ ;  $\nu=1.0$ ;  $f=(0.1; 0.3)$



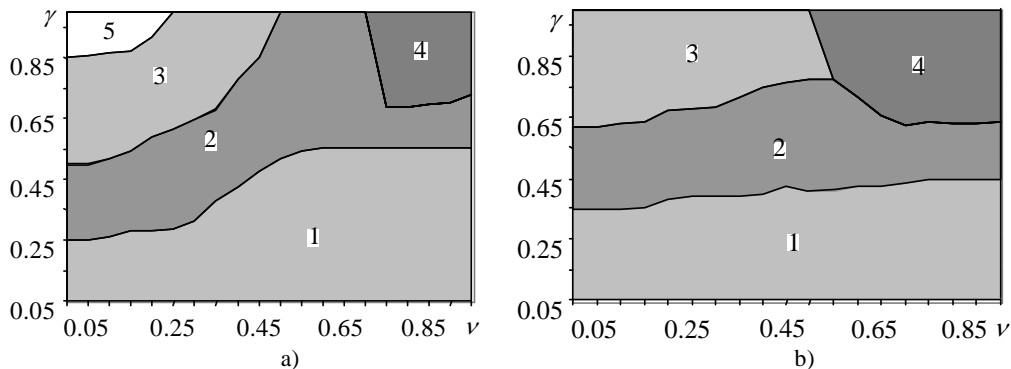
**Fig. 7.** Vibration of the body near the position of static equilibrium:  $h_l=0.01$ ;  $\alpha=0.1$ ;  $\beta=0.3$ ;  $\gamma=0.85$ ;  $\mu=1.0$ ;  $\nu=1.0$ ;  $f=(0.1; 0.3)$

The analysis of motion graphs indicates, that the body can take jerking motion of the body (Fig. 3), stick-slip displacement of the body and vibration near the position of dynamic equilibrium (Fig. 4), nearly periodical motion near the position of dynamic equilibrium (Fig. 5), decreasing displacement regime of the body motion (Fig. 6) and vibration of the body near the position of static equilibrium (Fig. 7).

It was determined by analysis, what higher amplitude vibrations near the position of static equilibrium occur only if dry friction coefficient is variable. Furthermore, the character of displacement  $\xi(\tau)$  dependencies changes, and displacement of the body during the predetermined time interval obtains bigger values (Fig. 7).

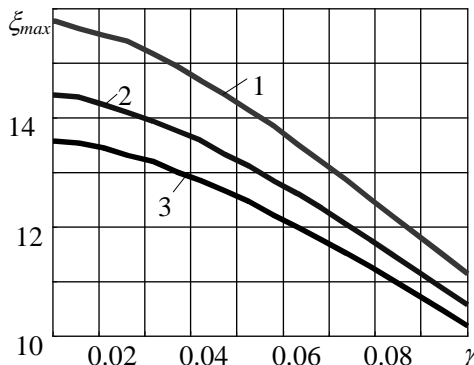
According to the simulation results existing areas motion regimes of the body at  $\gamma - \nu$  parameters plane, presented in Fig. 8, are determined. Parameter  $\nu$  is proportional to the static force of the body pressing to the plane. Furthermore, 1 and 2 areas are largest when dry friction coefficient has smaller meaning ( $f=0.1; 0.2$ ). Also change the 4 and 3 areas, which depends from the range of the friction coefficient: when range of coefficient is bigger the third and fourth areas are increases. Expanding the range of the friction coefficient, results disappear the area, where growing amplitude vibrations of the body near the position of static equilibrium are taking place (5 area).

Determined areas assist in selection of design and excitation parameters of vibratory assembly devices in order to obtain such a character of the movably based part displacement during the matching, which optimally meets technological requirements of the assembly.

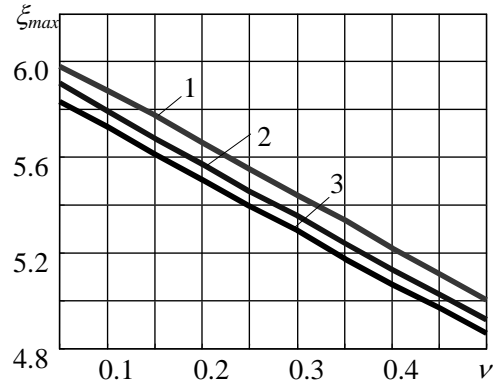


**Fig. 8.** Areas of  $\gamma$  and  $\nu$  parameters sets, which characterize regimes of the body motion: a -  $f=(0.1; 0.2)$ ; b -  $f=(0.1; 0.4)$ , when  $\tau_1=0$  and  $\tau_2=\pi$

Connecting surfaces could be matched only if movably based part can move from the position of static equilibrium by a distance, which is not less than misalignment between the axes of the parts that are located on the assembly position. Thus it is important to determine the influence of system's parameters on the body displacement. Dependencies of maximum displacement  $\xi_{max}$  on the system parameters, when predetermined by the first area\_motion regime is taking place, are identified. As elastic resistance force along the direction of the body motion, depending on rigidity of locating elements, increases, displacement  $\xi_{max}$  rapidly decreases (Fig. 9). The dependencies are nonlinear.



**Fig. 9.** Graphs of  $\xi_{max}(\gamma)$ :  $h_I=0.01$ ;  $\alpha=0.1$ ;  $\beta=0.3$ ;  $\mu=1.0$ ;  $\nu=0.05$ ; 1 -  $f=(0.1; 0.2)$ ; 2 -  $f=(0.1; 0.3)$ ; 3 -  $f=(0.1; 0.4)$



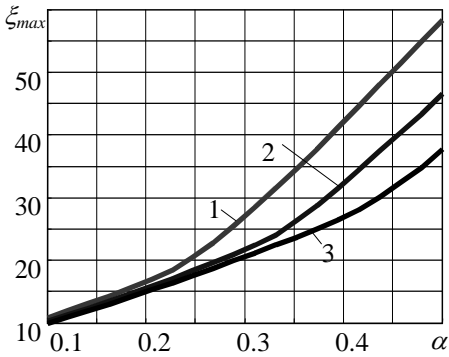
**Fig. 10.** Graphs of  $\xi_{max}(\nu)$ :  $h_I=0.01$ ;  $\alpha=0.1$ ;  $\beta=0.3$ ;  $\mu=1.0$ ;  $\gamma=0.20$ ; 1 -  $f=(0.1; 0.2)$ ; 2 -  $f=(0.1; 0.3)$ ; 3 -  $f=(0.1; 0.4)$

Displacement  $\xi_{max}$  is related to parameter  $\nu$  by linear dependencies (Fig. 10). This parameter characterizes the force of normal pressing of the body to the plane. Having aim to avoid impacts, it is necessary to apply such pressing force, that the body does not loses contact with the plane due to vibratory excitation.

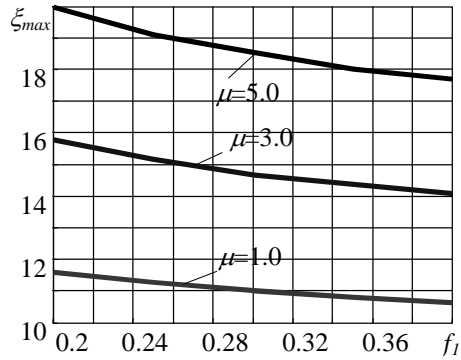
Because of initial pressing force, movably based part tilts by particular angle in respect to mating part. This angle in dynamic model is presented as the plane tilt angle  $\alpha$ . At small values of  $\alpha$ , dependencies  $\xi_{max}(\alpha)$  are not completely linear and displacement  $\xi_{max}$  changes a little (Fig. 11).

As high frequency vibrations are not running, friction force acting against the displacement depends not only on normal pressing force  $N(t)$ , but also on friction coefficient  $f_1$ , which is determined by the material of contacting parts and quality of their surfaces. When elastic vibrations are excited, friction coefficient obtains value  $f_2$  that is always smaller than  $f_1$ . The character of dependences  $\xi_{max}(f_1)$  changes, depending on mass of the body taking displacement, which is characterized by dimensionless parameter  $\mu$  (Fig. 12).

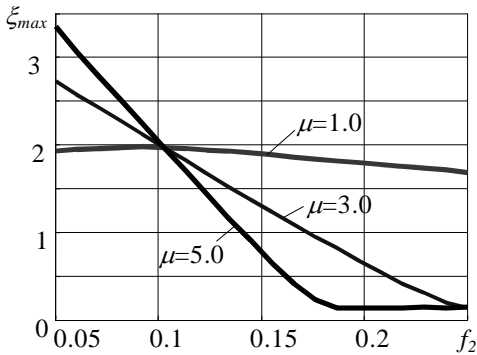
The value of coefficient  $f_2$  depends on the technique the excited high frequency vibrations and on the amplitude of mentioned vibrations. As mass of the body obtains bigger values, dependencies  $\xi_{max}(f_2)$  change, as compared to graphs  $\xi_{max}(f_1)$  (Fig. 13).



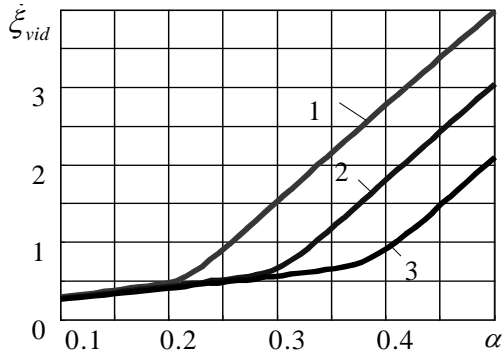
**Fig. 11.** Graphs of  $\xi_{max}(\alpha)$ :  $h_j=0.01$ ;  $\alpha=0.1$ ;  $\beta=0.3$ ;  $\mu=1.0$ ;  $\gamma=0.10$ ;  $\nu=0.10$ ; 1 -  $f=(0.1; 0.2)$ ; 2 -  $f=(0.1; 0.3)$ ; 3 -  $f=(0.1; 0.4)$



**Fig. 12.** Graphs of  $\xi_{max}(f_1)$ :  $h_j=0.01$ ;  $\alpha=0.1$ ;  $\beta=0.3$ ;  $\mu=1.0$ ;  $\gamma=0.10$ ;  $\nu=0.20$ ;  $f_2=0.05$



**Fig. 13.** Graphs of  $\xi_{max}(f_2)$ :  $h_j=0.01$ ;  $\alpha=0.1$ ;  $\beta=0.3$ ;  $\mu=1.0$ ;  $\gamma=0.40$ ;  $\nu=0.20$ ;  $f_1=0.4$



**Fig. 14.** Graphs of  $\xi_{vid}(\alpha)$ :  $h_j=0.01$ ,  $\beta=0.3$ ,  $\mu=1.0$ ,  $\gamma=0.05$ ,  $\nu=0.05$

Average velocity of the body displacement from static to dynamic equilibrium position determines the duration of connecting surfaces matching and the duration of vibratory assembly. Average velocity could be calculated using the dependence:

$$\xi_{vid} = \frac{\xi_{max}}{\tau} \quad (2)$$

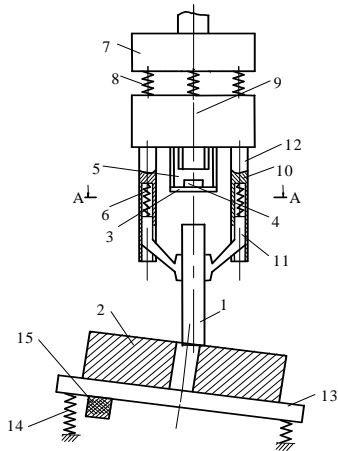
where  $\xi_{max}$  is maximum displacement of the body;  $\tau$  is time the body moves  $\xi_{max}$  distance.

The nature of dependencies  $\xi_{vid}(\gamma)$ ,  $\xi_{vid}(\nu)$  and  $\xi_{vid}(\alpha)$ , when friction coefficients  $f_1$  and  $f_2$  and time moments for the actuation and de-actuation of high frequency vibrations are predetermined, is similar to the dependencies of maximum displacement  $\xi_{max}$  on same parameters.

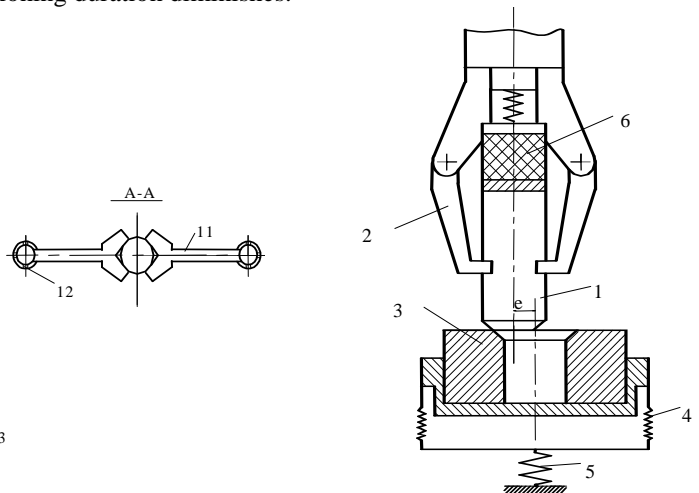
### Schemas of vibratory assembly mechanisms

Based on results of performed investigation, were designed schemas of vibratory assembly mechanisms for automated assembly parts, having cylindrical cross-section. Mutual orientation of the parts, applying vibratory alignment to one of the parts, ensures reliable positioning of both parts and their joining. Applied method of vibratory assembly under dry friction control allows inaccurate location of the parts in assembly position. Here are presented example of schema of the vibratory assembly device for cylindrical parts assembly.

In assembly mechanism (Fig. 15) for cylindrical parts positioning, a shaft 1 is based in prisms attached to the gripper jaws 11, mounted within the lever elements 10, which containing elastic elements 6. The base 7 of the assembly mechanism through elastic elements 8 is attached to vibrating platform 9. The bushing 2 is movably (freely) based on the springing base 13, whereas shaft 1 is grasped by the gripper and located above the bushing 2. Piezoelectric vibrator 15 is attached to the base 13, to provide high frequency elastic vibrations to the base. Under existing axial misalignment of the connective surfaces, lower end of the shaft 1 contacts the rim of the bushing's hole, while the upper end is pressed to the elastic element 3. The electromagnet 5 through the elastic element 3 excites axial vibrations of the shaft, as a result the bushing 2 displaces along the base 13 and so the parts are positioned and connective surfaces get matched. Due to elastic vibrations of the base 13, dry friction force between the bushing and the base diminishes and therefore, positioning duration diminishes.



**Fig. 15.** Schema of vibratory device for cylindrical parts assembly



**Fig. 16.** Schema of vibratory device for cylindrical shape parts with chamfers assembly: 1 – shaft; 2 – robot gripper; 3 – bushing; 4, 5 –elastic elements; 6 - piezoelectric vibrator

The other schema of mechanism is designed for assembly of the cylindrical shape parts with chamfers (Fig. 16). Having chamfers mobile based bushing 3 is on a base, with located here elastic (spring) elements 4, 5, which ensure plane transverse displacement of the connective surfaces along the horizontal plane. The shaft, with chamfers 1 at a lower end, is gripped in the to the robot gripper 2, whereas to the other end of the shaft a piezoelectric vibrator 6 is attached, which excites elastic vibrations of the shaft. The vibrator excites the radial and axial vibrations of the shaft. Therefore, the end of the shaft vibrates along an elliptic trajectory. The driving friction force emerges, which pushes the bushing towards the axial alignment and thus the shaft under the influence of assembly force is inserted into the hole of the bushing.



## Conclusions

New vibratory method for mutual positioning of the being assembled parts is proposed in this work, as one of the parts is rigidly based, whereas the other is based movably and vibratory excited, while dry friction coefficient is controlled by high frequency elastic vibrations:

1. Vibratory displacement of the elastically constrained and damped part was analyzed, as dry friction coefficient is controlled at particular time intervals, exciting elastic vibrations. Based on made model, by numerical simulation it was determined, that under controlled dry friction, the areas of the system and excitation parameters sets exist, with 5 possible motion regimes: jerking motion of the body, stick-slip displacement of the body and vibration near the position of dynamic equilibrium, nearly periodical motion near the position of dynamic equilibrium, vibration of the body near the position of static equilibrium and decreasing displacement regime of the body motion.

2. It was determined, that increasing amplitude vibrations near the position of static equilibrium occur only under varying coefficient of dry friction. Most suitable for automated assembly are regimes of the periodical motion near the position of the dynamic equilibrium and vibrations of the body near the position of the static equilibrium.

3. It was explored, that maximum displacement  $\xi_{max}$ , controlling dry friction, always is longer, than that under constant friction coefficient. Most influence on displacement of the body has the frequency ratio of the system's natural vibration along the  $\xi$  direction to excitation frequency and initial force of the body pressing to the plane.

4. Based on performed part-to-part positioning analysis, were designed vibratory assembly devices, under control of the dry friction, those may be used for joining of the cylindrical cross-section parts. Due to directional vibratory displacement of the one part from the mating pair, no need for high accuracy of the parts placement in assembly position.

## Acknowledgements

This work was supported by Lithuanian State Science and Studies Foundation.

## References

- [1] **Fedaravičius A., Tarasevičius K.** Dynamic of Vibratory Transportation and Orientation Systems. - Kaunas: Technologija, 1998. - 148 p. (in Lithuanian).
- [2] **Bakšys B., Fedaravičius A.** Vibratory Systems and Mechanisms for Automated Manipulation.- Kaunas: Technologija, 2004, 373 p. (in Lithuanian).
- [3] **Sudsang A., Kavraki L. E.** A Geometric Approach to Designing a Programmable Force Field with a Unique Stable Equilibrium for Parts in the Plane. Proceedings of the 2001 IEEE International Conference on Robotics and Automation (ICRA), IEEE Press, p. 1079-1085.
- [4] **Bakšys B., Sokolova T.** Vibratory Displacement and Turn of the Body Controlled by Dry Friction. Mechanics, 2004, No. 1(45), p. 10-18.
- [5] **Bakšys B., Fedaravičius A., Sokolova T.** The Research of Vibratory Displacement and the Turn of Automatically Assembled Parts Controlling Dry Friction Force. Proceedings of the First Cappadocia International Mechanical Engineering Symposium, July 14-16 2004, Cappadocia, Turkey, Nigde: Nigde University, 2004, p. 615-622.
- [6] **Sokolova T., Bakšys B.** Matching of Connective Surfaces Controlling Dry Friction Force. Vibroengineering 2004, Proceedings of 5<sup>th</sup> International Conference, October 14-15, 2004, Kaunas, Lithuania. ISSN 1392-8716. 2004. p. 106-110.
- [7] **Sokolova T., Bakšys B.** Vibratory Displacement and Turn of the Body Controlling Dry Friction. Mechanika - 2004: Proceedings of the 9<sup>th</sup> International Conference, April 1-2, 2004, Kaunas University of Technology, Lithuanian Academy of Science, IFTOMM National Committee of Lithuania, Baltic Association of Mechanical Engineering. ISBN 9955-09-630-6. 2004, p. 442-447 (in Lithuanian).
- [8] **Bakšys B., Sokolova T.** Vibratory Displacement of the Body Controlling Dry Friction Force. Mechanics, 2003, No. 4(42), p. 44-50.